

Using scale factors

1 a) Here is a rectangle.

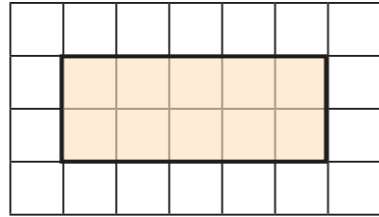

Draw another rectangle where each side is twice as big.

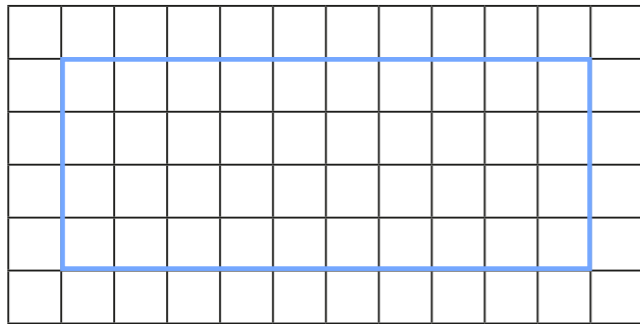

b) Here is a square.

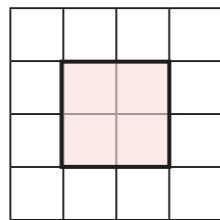

Draw another square where each side is 4 times as big.

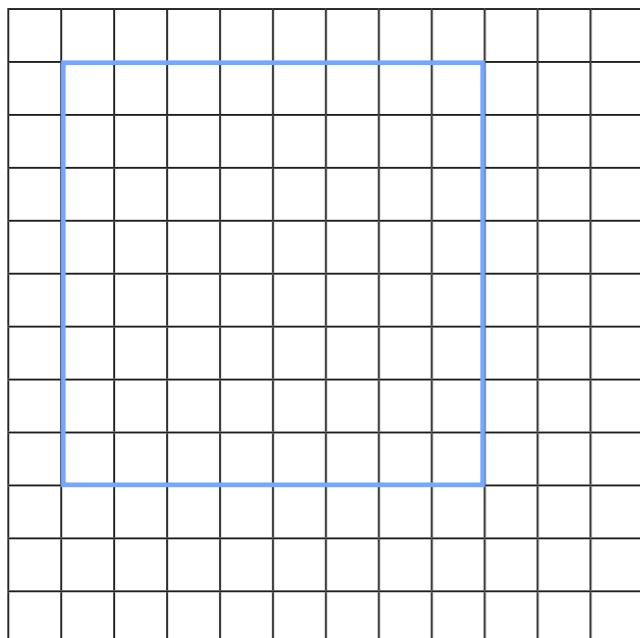

2 a) Explain what it means for a shape to be enlarged by a scale factor of 2

b) Enlarge the shapes by a scale factor of 2

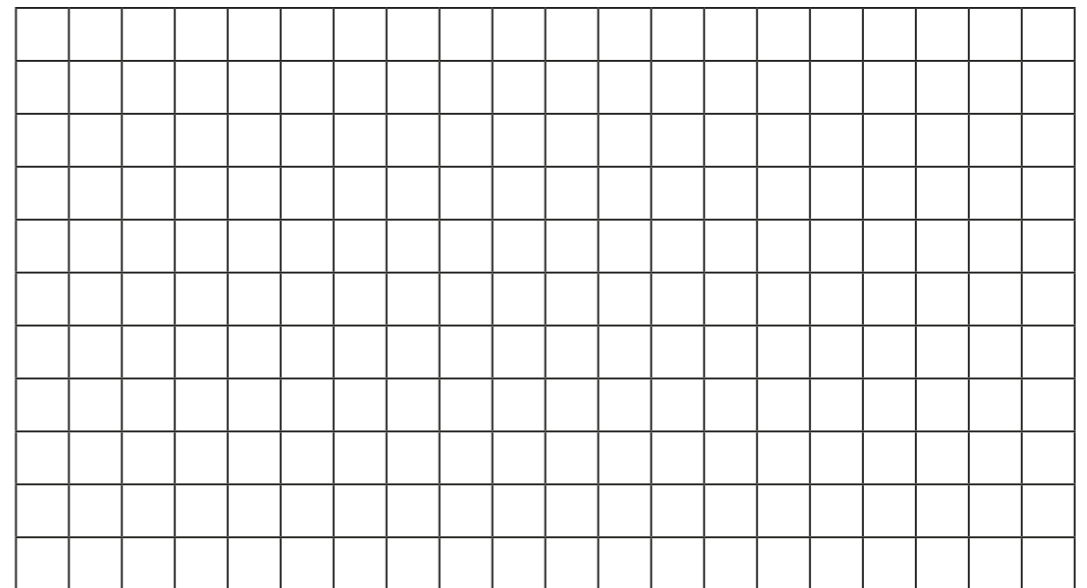
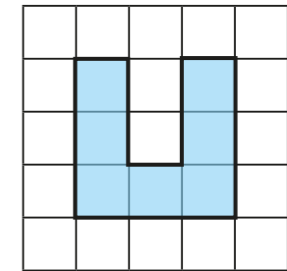
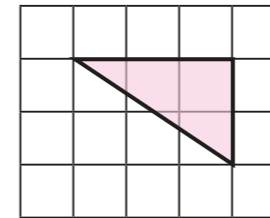

3 Complete the sentence.

A shape in which each side has tripled in size has been enlarged by a scale factor of



- 4 Here is a rectangle.



- a) Measure the side lengths of the rectangle and label them on the diagram.
 b) Enlarge the rectangle by a scale factor of 3 and label the side lengths.

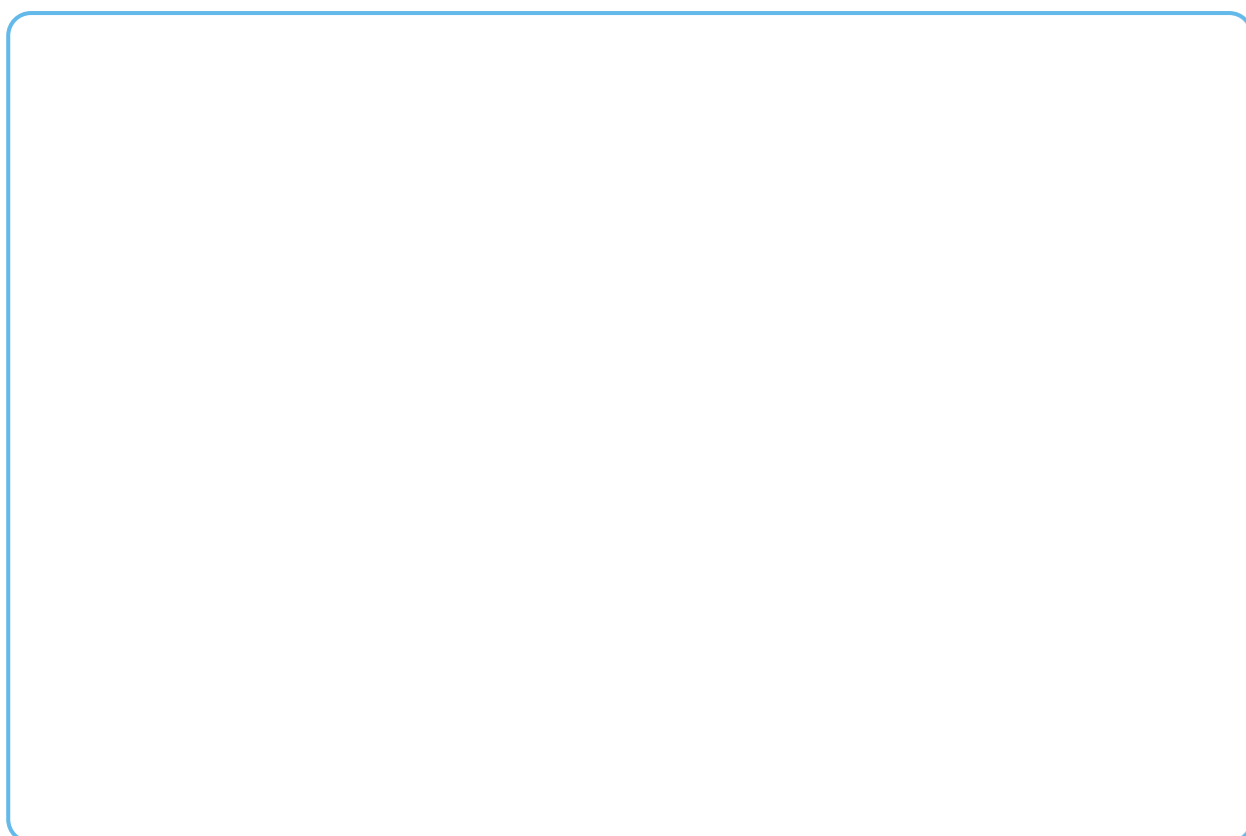

- 5 The sides of the rectangle are increased by a scale factor of 2
 What is the perimeter of the new shape?

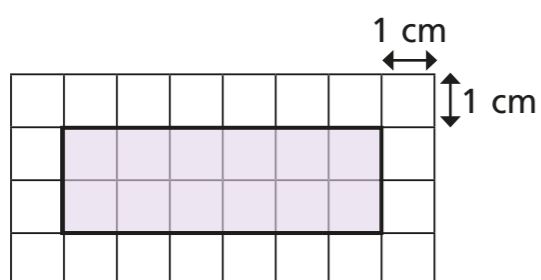

cm

- 6 The shape has been enlarged by a scale factor of $1\frac{1}{2}$
 Fill in the dimensions of the new shape.

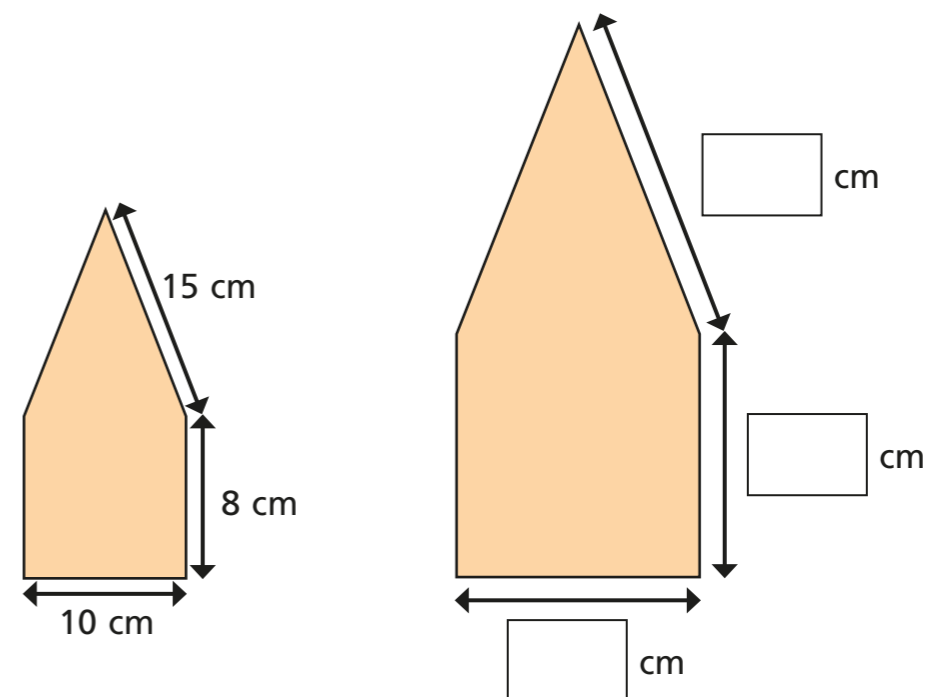

- 7 Triangle A has been enlarged by a scale factor of 5 to make triangle B.
 Find the perimeter of each triangle.

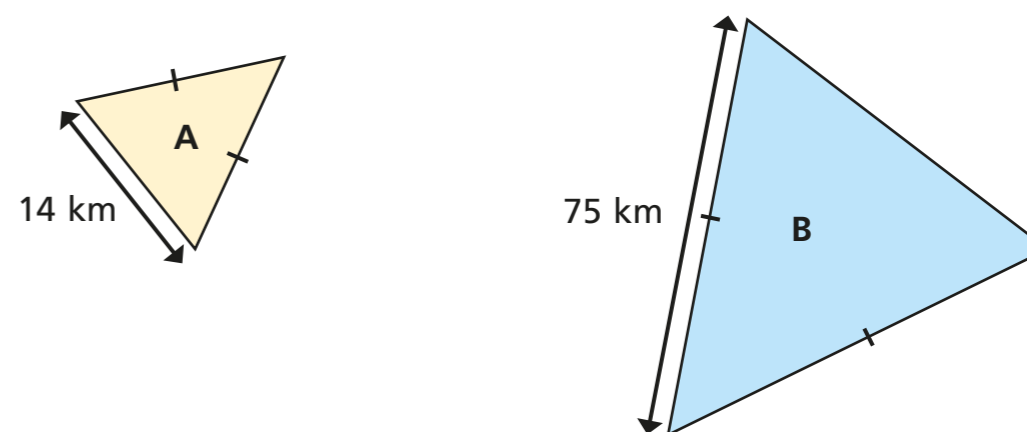

perimeter of A = perimeter of B =

